

PARTS LIST

MODEL:2160DC, DXL603

PARTS LIST

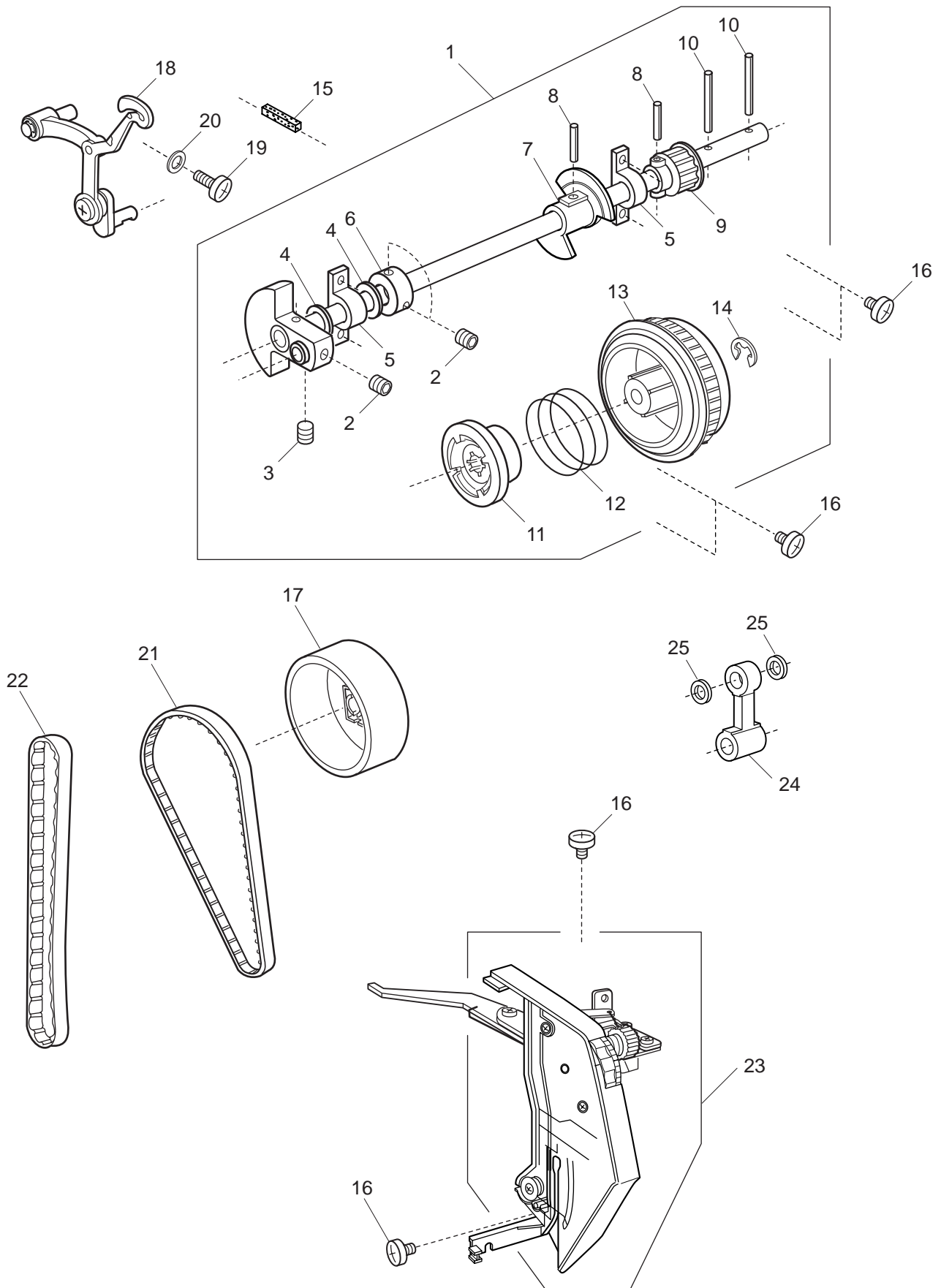

PARTS LIST

KEY NO.	PARTS NO.	DESCRIPTION
1	808601005	Upper shaft (unit)
2	000111201	Hexagonal socket screw 4x4
3	000112800	Hexagonal socket screw 4x6
4	000036201	Washer FT80
5	508054008	Shaft fixing metal
6	820166001	Lower shaft ring
7	808003001	Upper shaft shielding plate
8	000004200	Spring pin 3x18
9	508021006	Upper shaft gear
10	000024206	Spring pin 3x30
11	502064003	Clutch ring
12	661024007	Clutch spring
13	508055009	Belt wheel
14	000002806	Snap ring E-6
15	731312005	Felt
16	000081005	Setscrew 4x8
17	508056000	Handwheel
18	508634101	Thread take-up lever (unit)
19	000103509	Setscrew 4x10
20	000072302	Washer 4
21	808021005	Timing belt
22	808037004	Syncro belt
23	808511007	Thread tension (unit)
24	808005003	Needle bar crank rod
25	000036005	Washer FT60

PARTS LIST

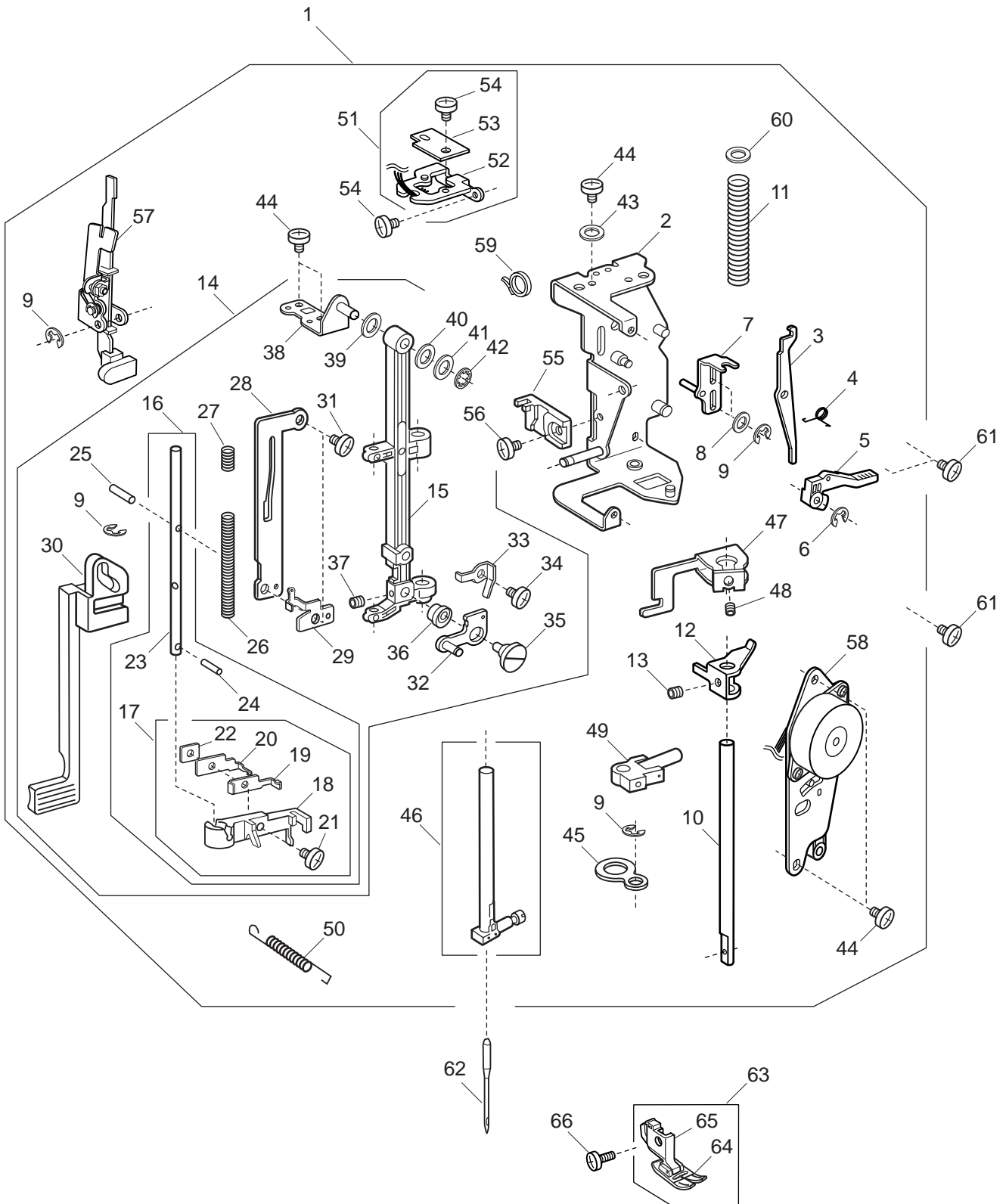

PARTS LIST

KEY NO.	PARTS NO.	DESCRIPTION
1	808640006	Presser bar base plate (unit)
2	808006200	Presser bar base plate
3	808007005	Thread tension release lever
4	503041007	Thread tension release spring
5	502024001	Presser foot lifter
6	000001609	Snap ring E-5
7	808076005	Presser bar spring adjusting plate
8	000072508	Washer 4
9	000002105	Snap ring E-3
10	508002104	Presser bar
11	808081003	Presser bar spring
12	508039007	Presser bar supporter
13	000111500	Hexagonal socket screw 4x8
14	808603007	Needle bar supporter (unit)
15	808008006	Needle bar supporter
16	842637006	Threader shaft (unit)
17	842638007	Threader plate (unit)
18	755064106	Threader guard plate
19	842088006	Thread retention plate
20	844095002	Threader plate
21	755096004	Setscrew
22	755095003	Nut
23	840036025	Threader shaft
24	000003508	Spring pin 2x8
25	000125105	Guide pin E-2x16-CH
26	842090001	Threader shaft spring
27	842096007	Threader lever spring
28	842091002	Threader guide plate
29	844036027	Threader lever plate
30	842092003	Threader lever
31	000078319	Setscrew 3x6
32	808015006	Zigzag width rod
33	827088009	Zigzag width rod spring
34	820373003	Setscrew 2x3
35	678084007	Eccentric pin
36	808074003	Washer
37	000111902	Hexagonal socket screw 3x4
38	808009007	Supporter adjusting plate
39	000036500	Washer FT60
40	673022002	Spring washer
41	000070609	Washer 6
42	000013903	Snap ring CS-5
43	000072003	Washer 5
44	000101404	Setscrew 4x6
45	808010001	Supporter guide plate
46	508607105	Needle bar (unit)
47	808011002	Threader position set plate
48	000177205	Hexagonal socket screw 4x4
49	508509003	Needle bar connecting stud (unit)
50	844038018	Needle bar supporter spring
51	808606000	Buttonhole sensor (unit)
52	845002005	Sensor set plate
53	843502602	Printed circuit board E1 (unit)
54	000101105	Setscrew 3x4
55	830057021	Buttonhole lever guide
56	000103808	Setscrew 3x5
57	843625004	Buttonhole lever (unit)
58	808605009	Zigzag width motor (unit)
59	000053008	Cord binder
60	625102008	Washer
61	000081005	Setscrew 4x8
62	102408089	Needle HA1-14
63	660509008	Presser foot (unit)
64	832523007	Zigzag foot
65	660806008	Presser foot holder
66	660106001	Setscrew

PARTS LIST

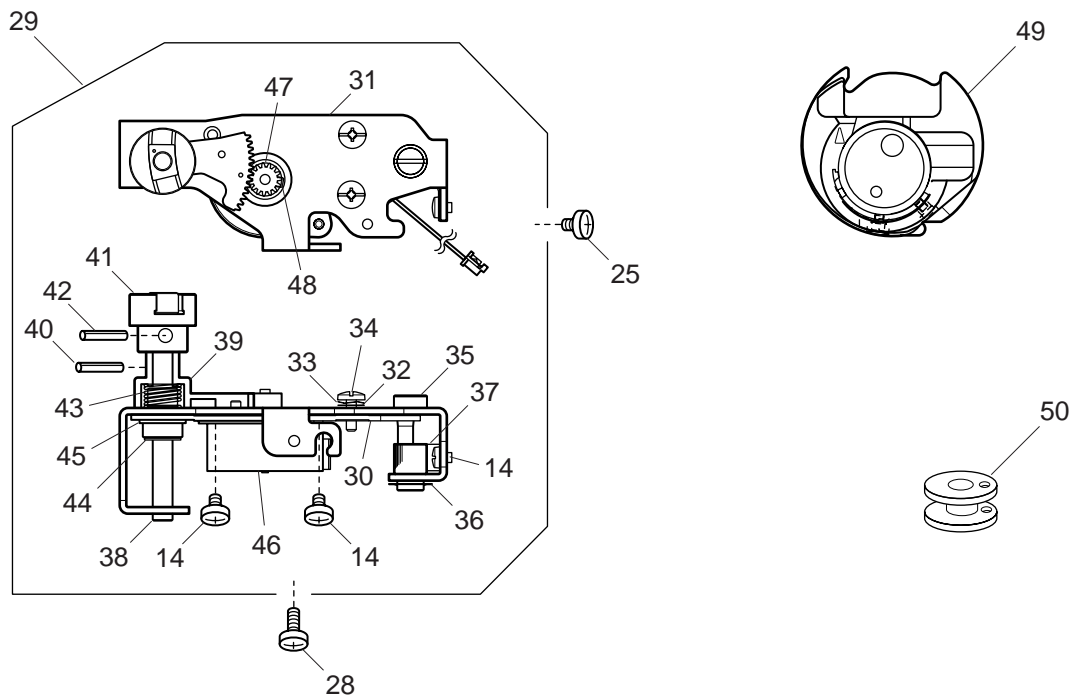
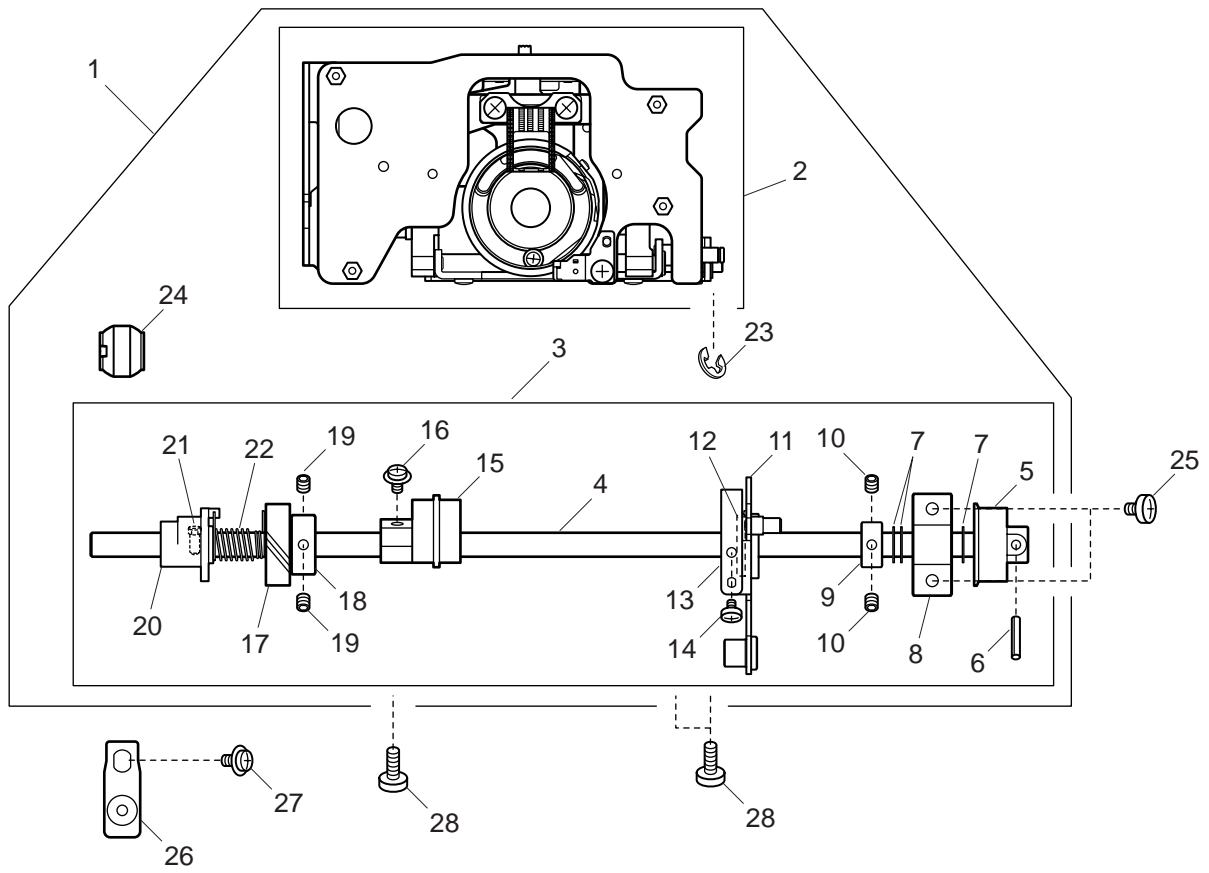

PARTS LIST

KEY NO.	PARTS NO.	DESCRIPTION
1	808632005	Hook race (whole unit)
2	808629009	Hook race (unit)
3	808634007	Lower shaft (unit)
4	808027001	Lower shaft
5	508021006	Upper shaft gear
6	000004200	Spring pin 3x18
7	000038502	Washer
8	508054008	Shaft fixing metal
9	820166001	Lower shaft ring
10	000111201	Hexagonal socket screw 4x4
11	808028002	Feed fork
12	751150005	Actuator plate
13	808026000	Feed fork spring
14	000101105	Setscrew 3x4
15	808029003	Feed cam
16	000115009	Setscrew TP 3x8
17	508023008	Lower gear
18	508020005	Ring
19	000111108	Hexagonal socket screw 4x6
20	753183025	Feed lifting cam
21	820161006	Feed lifting pin
22	686035008	Feed lifting cam spring
23	000002507	Snap ring E-4
24	732034003	Lower shaft bushing
25	000081005	Setscrew 4x8
26	808098003	Lower shaft bushing set plate
27	000115607	Setscrew TP 4x8
28	000101703	Setscrew 4x12
29	808613000	Feed motor (unit)
30	808030007	Feed motor set plate
31	808031008	Feed regulator shaft supporter
32	000071013	Washer 4
33	000116103	Spring washer 4
34	823038002	Setscrew
35	808033000	Feed regulator shaft
36	000014409	Snap ring CS-8
37	808096001	Feed regulator shaft spring
38	808034001	Feed regulator shaft
39	808035002	Feed regulator
40	000004004	Spring pin 2.5x10
41	625508204	Feed regulator (unit)
42	000004107	Spring pin 3x14
43	808094009	Feed regulator spring
44	000001609	Snap ring E-5
45	000013501	Snap ring CS-12
46	808509105	Stepping motor (unit)
47	808013004	Gear
48	000110406	Hexagonal socket screw 3x4 (WP)
49	627569106	Bobbin holder (unit)
50	102261000	Bobbin

PARTS LIST

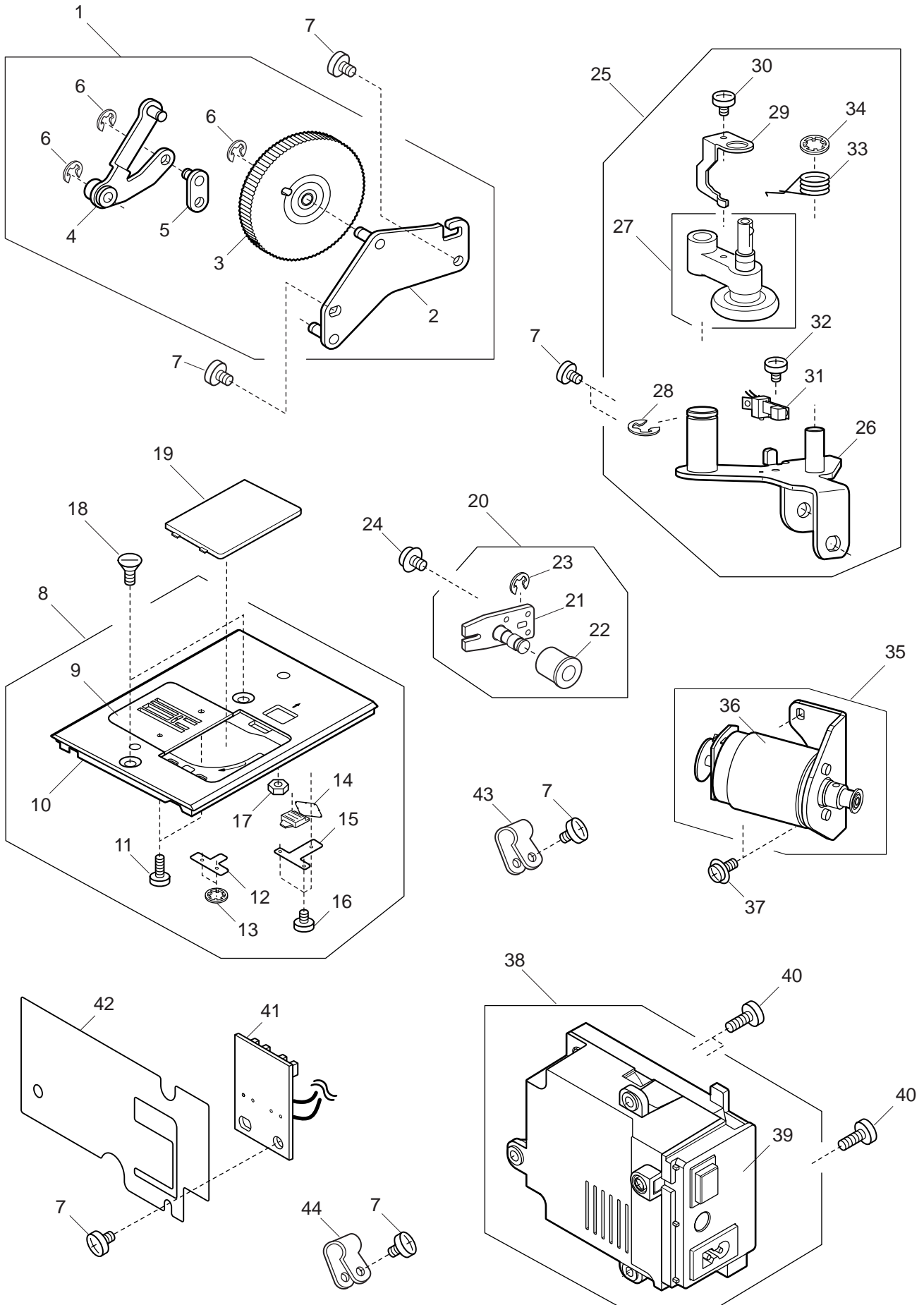

PARTS LIST

KEY NO.	PARTS NO.	DESCRIPTION
1	808618005	Presser foot pressure adjustment (unit)
2	808077006	Presser foot pressure adjusting set plate
3	808078100	Presser foot pressure dial
4	808079008	Adjusting arm 1
5	808080002	Adjusting arm 2
6	000002105	Snap ring E-3
7	000081005	Setscrew 4x8
8	808626006	Needle plate (unit)
9	808067003	Needle plate
10	808068004	Support needle plate
11	000163703	Setscrew 2x3.5
12	502015009	Spring
13	000015503	Snap ring SC-2.4
14	502016000	Hook cover plate release button
15	502202005	Supporter plate
16	000130206	Setscrew 1.7x2.5 (B)
17	508116009	Nut
18	820390109	Setscrew
19	846271103	Hook cover plate
20	808614001	Idler (unit)
21	808038005	Idler set plate
22	625217100	Idler
23	000002806	Snap ring E-6
24	000115607	Setscrew TP 4x8
25	808615002	Bobbin winder (unit)
26	808039006	Bobbin winder set plate
27	508507001	Bobbin winder arm (unit)
28	000001609	Snap ring E-5
29	508111004	Clutch lever
30	000120203	Setscrew 3x8 (B)
31	856512100	Reef switch (unit)
32	000081706	Setscrew 2.5x5
33	808040000	Spring
34	000013903	Snap ring CS-5
35	808617004	DC motor (unit)
36	808502005	DC motor (unit)
37	000115700	Setscrew TP 4x10
38	808639301	Switching regulator (unit) (U.S.A.)
	808639208	Switching regulator (unit) (Continental Europe) (UK)
39	808525303	Switching regulator (unit) (U.S.A.)
	808525200	Switching regulator (unit) (Continental Europe) (UK)
40	000103509	Setscrew 4x10
41	808504007	Printed circuit board P (unit)
42	808093008	Cord guide
43	000188209	Nylon clip ACC-1.5
44	000188405	Nylon clip ACC-2

PARTS LIST

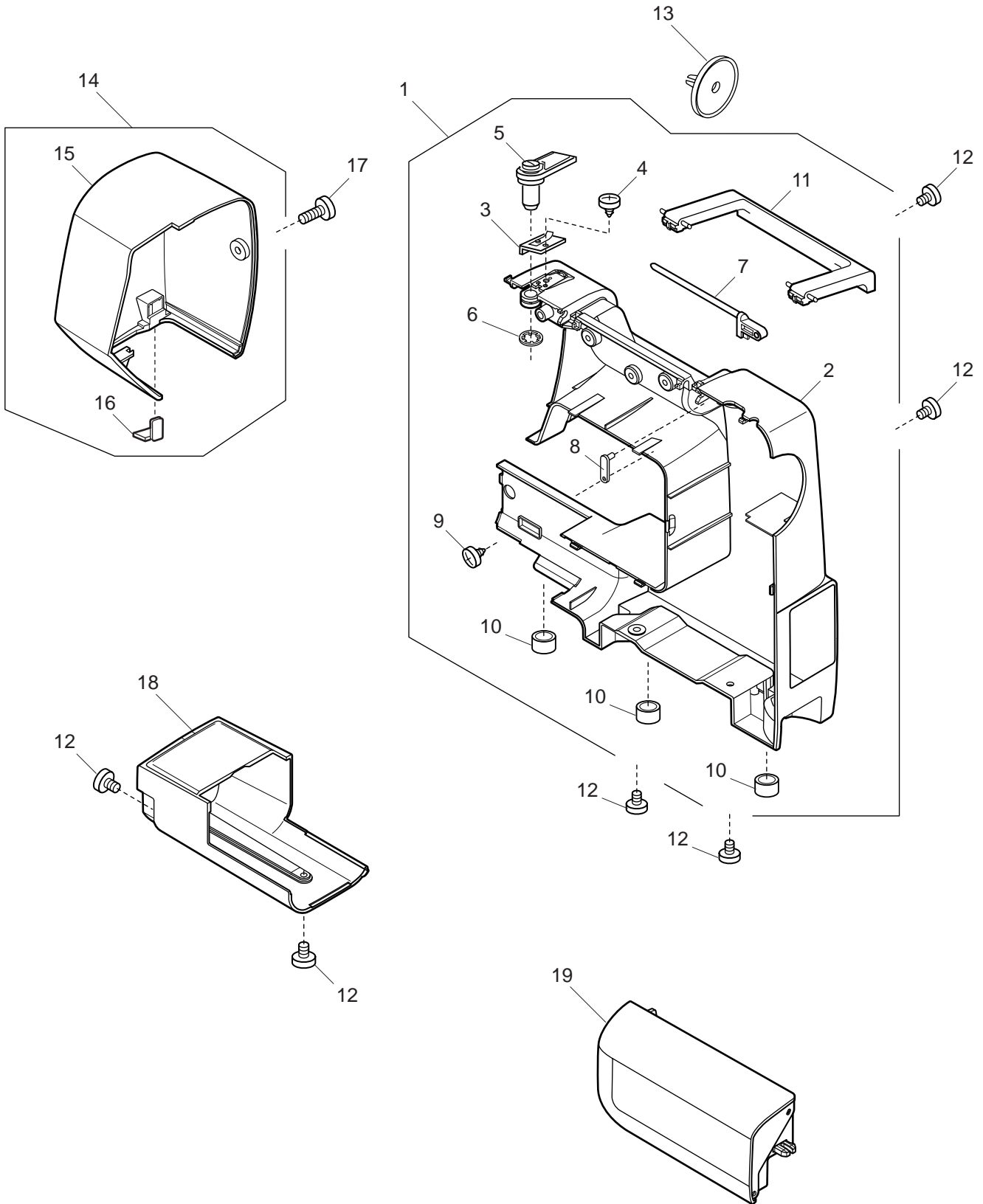

PARTS LIST

KEY NO.	PARTS NO.	DESCRIPTION
1	808619006	Rear cover (unit)
2	808050106	Rear cover
3	827503108	Top cover thread guide (unit)
4	000162001	Setscrew 2.6x5
5	650503403	Thread guide (unit)
6	000014409	Snap ring CS-8
7	502007008	Spool pin
8	502008009	Spool pin support plate
9	000120203	Setscrew 3x8 (B)
10	739064003	Bed rubber cushion
11	502009000	Carrying handle
12	000081005	Setscrew 4x8
13	822020503	Spool holder
14	808622105	Face plate (unit)
15	808060202	Face plate
16	840602006	Thread cutter (unit)
17	000104108	Setscrew 4x20
18	808061007	Free arm cover
19	808508001	Extension table (unit)

PARTS LIST

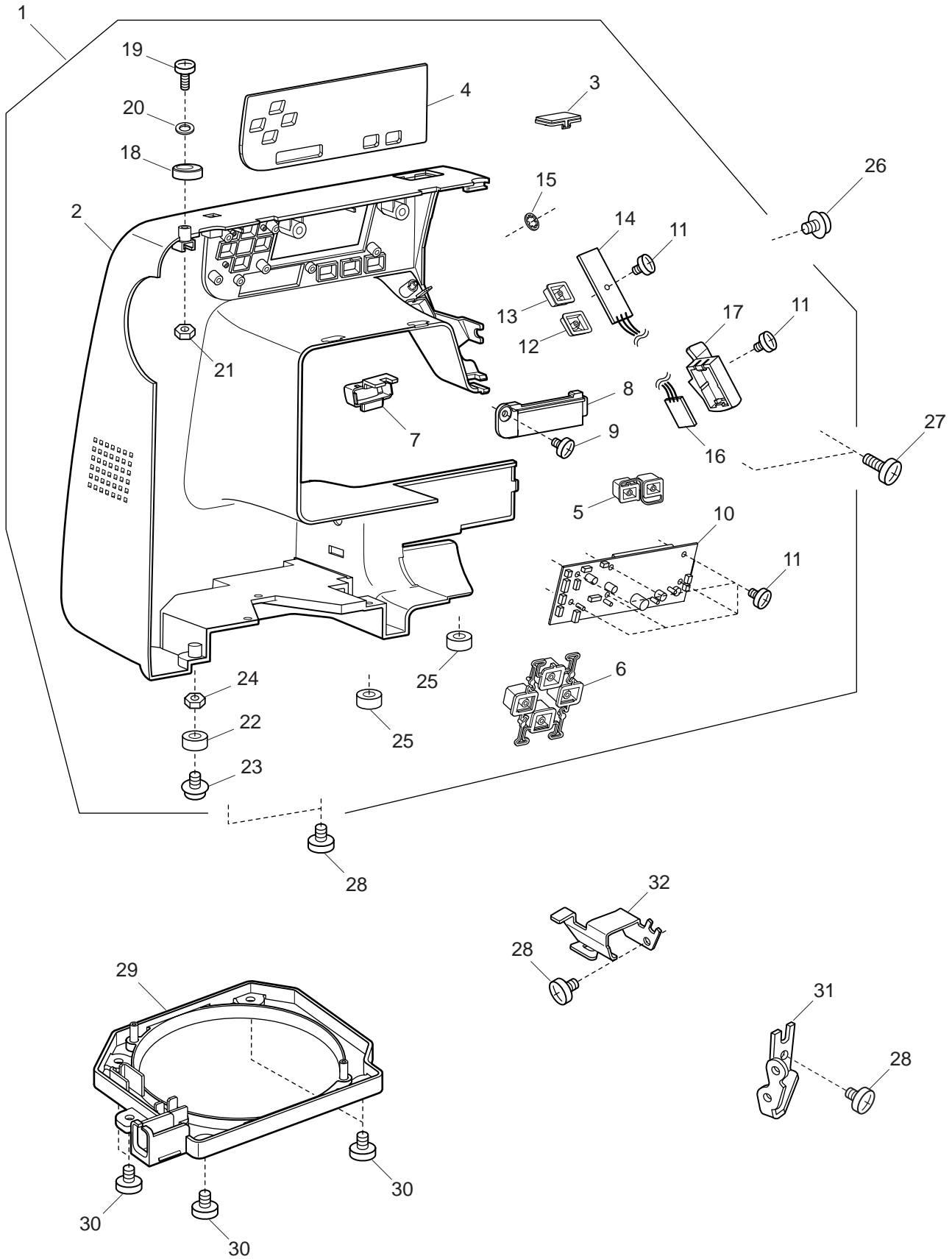

PARTS LIST

KEY NO.	PARTS NO.	DESCRIPTION
1	808630106	Front cover (unit) (U.S.A.) (Continental Europe)
	808630405	Front cover (unit) (UK)
2	808051200	Front cover (U.S.A.) (Continental Europe)
	808051705	Front cover (UK)
3	808103002	Front cover lid
4	808072104	Panel (U.S.A.) (Continental Europe)
	808072403	Panel (UK)
5	808071103	Button 1
6	808054100	Button 2
7	808055008	Slide volume
8	808056102	Slide volume set plate
9	000160700	Setscrew 2.6x6 (B)
10	808505008	Printed circuit board A (unit)
11	000120203	Setscrew 3x8 (B)
12	808058104	Start/stop button
13	808070102	Button 4
14	808507000	Printed circuit board F (unit)
15	000014306	Snap ring CS-3
16	808506009	Printed circuit board L (unit)
17	808057000	Lamp holder
18	735016307	Bobbin winder stopper
19	000101828	Setscrew 4x16
20	000071013	Washer
21	000061205	Nut 4-3-7
22	639005003	Rubber foot
23	000201405	Setscrew TP 4x16
24	000160102	Adjustable lock nut 4
25	739064003	Bed rubber cushion
26	000115205	Setscrew TP 4x6
27	000160401	Setscrew 4x16 (B)
28	000081005	Setscrew 4x8
29	808059105	Bed cover
30	000149312	Setscrew 3x8
31	639080002	Front cover set plate
32	808016007	Arm thread guide

PARTS LIST

1

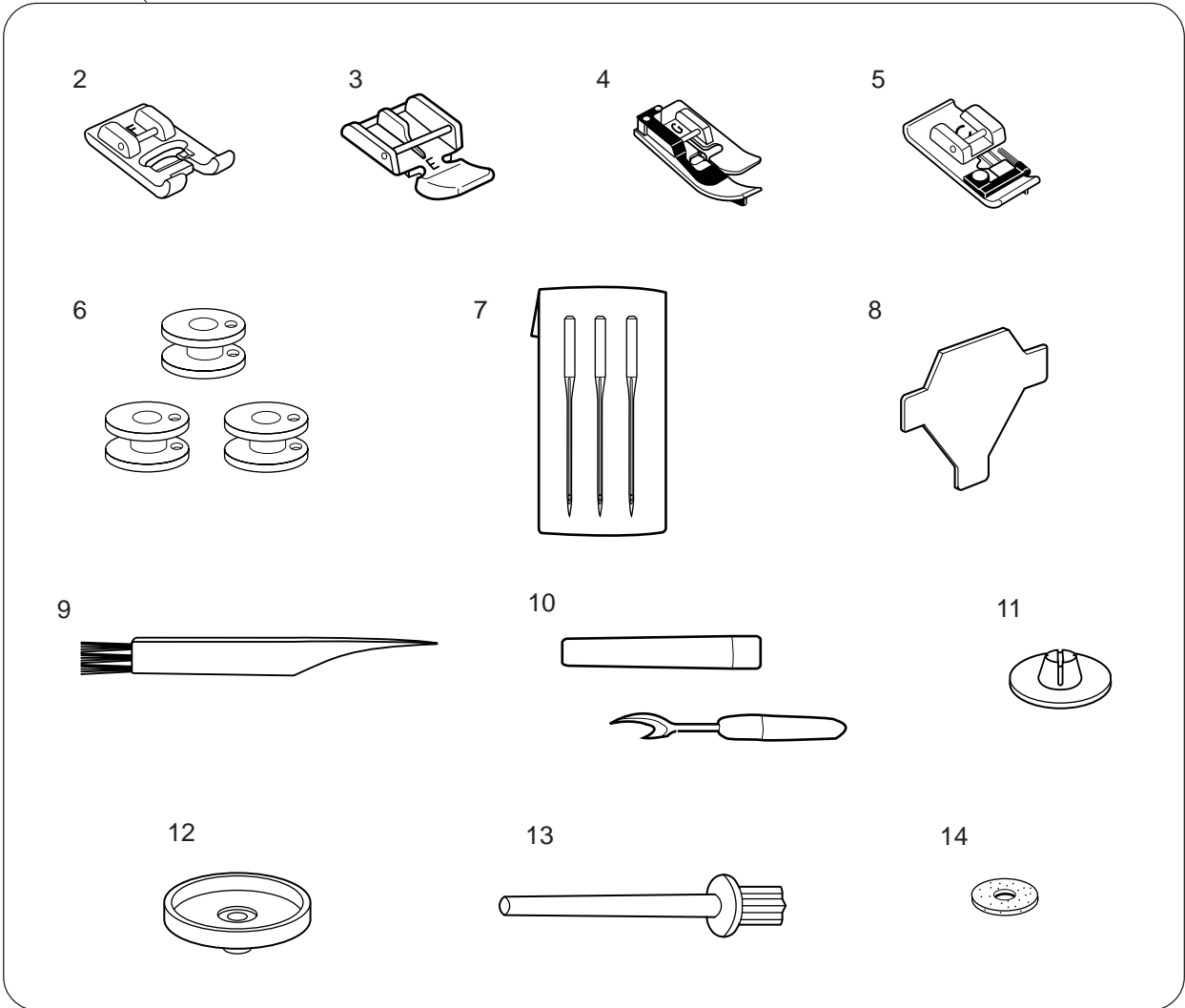

15

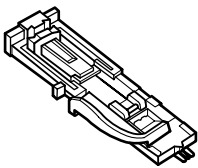

16

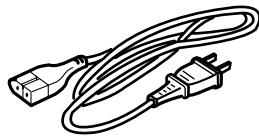

17

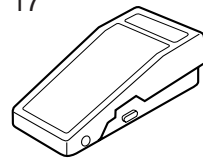

18

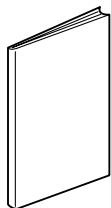

19

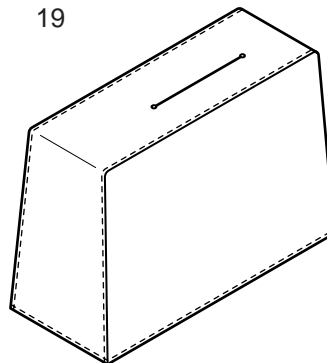

PARTS LIST

KEY NO.	PARTS NO.	DESCRIPTION
1	808870007	Attachment (unit)
2	822804118	Satin foot
3	829801002	Zipper foot
4	825817009	Blind hem foot
5	822801001	Overedge foot
6	102261000	Bobbin
7	639804000	Assorted needle set
8	653802002	Screw key
9	802424004	Lint brush
10	647808009	Seam ripper (Buttonhole opener)
11	822019509	Spool holder
12	829803004	Spool stand
13	625031500	Spool pin
14	102403109	Felt
15	753801004	BH foot
16	856519004	Power supply cord (U.S.A.)
	830335004	Power supply cord (Continental Europe)
	830377008	Power supply cord (UK)
17	C-1036	Foot control
18	808800109	Instruction book (U.S.A.)
	808800121	Instruction book (Continental Europe)
	808800109	Instruction book (UK)
19	741811000	Cover (U.S.A.) (Continental Europe)
	484701022	Cover (UK)